

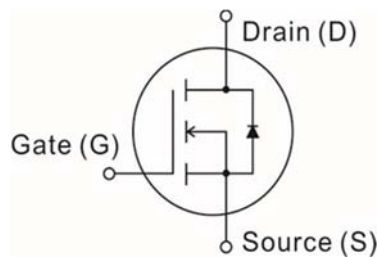

100V N-Channel Power MOSFET

**Product Summary**

Parameter	Value	Unit
$V_{DS} @ T_{jmax}$	100	V
$R_{DS(on),max} @ V_{GS} = 10\text{ V}$	5.0	mΩ
$I_D @ V_{GS} = 10\text{ V}$	130	A
$P_{tot}$	214	W

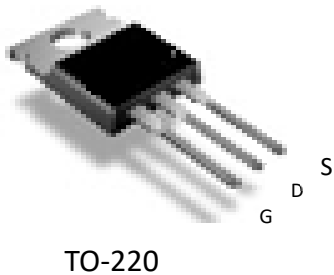

**Features**

- \* Low on-resistance
- \* Low gate threshold voltage
- \* Excellent FOM

**Application**

- \* Synchronous rectification
- \* BMS battery protection
- \* DC/AC inverter
- \* DC/DC converter

<b>Maximum ratings</b> ( $T_A = 25^\circ\text{C}$ unless otherwise noted)				
Parameter		Symbol	Limit	Unit
Drain - source voltage		$V_{DS}$	100	V
Continuous drain current	$T_c @ 25^\circ\text{C}$	$I_D$	130	A
	$T_c @ 100^\circ\text{C}$		110	
Pulsed drain current tp limited by $T_j$ max (Note 1)	$T_c @ 25^\circ\text{C}$	$I_D$ pulsed	420	A
Single pulse avalanche energy (Note 2)		$E_{AS}$	200	mJ
Gate-source voltage		$V_{GS}$	$\pm 20$	V
Power dissipation	$T_c @ 25^\circ\text{C}$	$P_{tot}$	214	W
Storage temperature range		$T_{STG}$	- 55 to +175	$^\circ\text{C}$
Operating junction temperature range		$T_j$	- 55 to +175	$^\circ\text{C}$



100V N-Channel Power MOSFET

<b>Electrical characteristics</b> ( $T_A = 25^\circ\text{C}$ unless otherwise specified)						
Parameter	Test Conditions	Symbol	Min.	Typ.	Max.	Units
<b>Off characteristics</b>						
Drain-source breakdown voltage	$V_{GS} = 0\text{V}, I_D = 250\mu\text{A}$	$BV_{DSS}$	100	---	---	V
Gate-source leakage	$V_{GS} = \pm 20\text{V}, V_{DS}=0\text{V}$	$I_{GSS}$	---	---	$\pm 100$	nA
Zero gate voltage drain current	$V_{DS}= 100\text{V}, V_{GS}= 0\text{V}, T_j=25^\circ\text{C}$ $T_j=125^\circ\text{C}$	$I_{DSS}$	---	0.1	1	uA
			---	---	100	
<b>On characteristics</b>						
Drain-source on-state resistance	$V_{GS} = 10\text{V}, I_D = 50\text{A}, T_j=25^\circ\text{C}$	$R_{DS(on)}$	---	4.3	5.0	m $\Omega$
	$V_{GS} = 6\text{V}, I_D = 20\text{A}, T_j=25^\circ\text{C}$		---	4.8	---	
Gate-source threshold voltage	$V_{DS} = V_{GS}, I_D = 250\mu\text{A}$	$V_{GS(th)}$	1.5	2.0	2.5	V
Transconductance	$V_{DS} \geq 2 \cdot I_D \cdot R_{DS(on)max}, I_D=20\text{A}$	$g_{fs}$	---	73	---	S
Gate resistance	$f = 1\text{MHz}, \text{open drain}$	$R_G$	---	0.31	---	$\Omega$
<b>Dynamic and switching characteristics</b>						
Gate-source charge	$V_{DD} = 50\text{V}, I_D = 50\text{A}$ $V_{GS} = 0 \text{ to } 10\text{V}$	$Q_{gs}$	---	12	---	nC
Gate-drain charge		$Q_{gd}$	---	13	---	
Gate charge total		$Q_g$	---	50	---	
Turn-on delay time	$V_{DD} = 50\text{V}, I_D = 30\text{A}$ $V_{GS} = 10\text{V}, R_{G,ext} = 3\Omega$	$T_{d(on)}$	---	14	---	ns
Rise time		$T_r$	---	45	---	
Turn-off delay time		$T_{d(off)}$	---	30	---	
Fall time		$T_f$	---	12	---	
Input capacitance	$V_{GS} = 0\text{V}, V_{DS} = 50\text{V}, f = 1\text{MHz}$	$C_{iss}$	---	3300	4290	pF
Output capacitance		$C_{oss}$	---	540	702	
Reverse transfer capacitance		$C_{rss}$	---	40	---	
<b>Drain-source diode characteristics and maximum ratings</b>						
Inverse diode forward voltage	$I_S = 50\text{A}, V_{GS} = 0\text{V}$	$V_{SD}$	---	0.9	1.1	V
Reverse recovery time	$V_R = 50\text{V}, I_F = 40\text{A},$ $di_F / dt = 100\text{A} / \mu\text{s}$	$t_{rr}$	---	57	---	ns
Reverse recovery charge		$Q_{rr}$	---	111	---	nC
Peak reverse recovery current		$I_{rm}$	---	3.9	---	A

Notes:

1. Repetitive rating : pulsed width limited by maximum junction temperature.
2.  $V_{DD}=50\text{V}$ , starting  $T_j=25^\circ\text{C}$ .



100V N-Channel Power MOSFET

Thermal characteristics			
Thermal resistance junction-to-ambient	R <sub>thJA</sub>	62	°C / W
Thermal resistance junction-to-case	R <sub>thJC</sub>	0.70	

Package Marking and Ordering Information

Type / Ordering Code	Package	Packaging	Related Links
I3GT050N10	TO-220	Tube	see Package outline

Electrical characteristics diagrams

Fig 1: Power dissipation

$P_{tot} = f(T_c)$

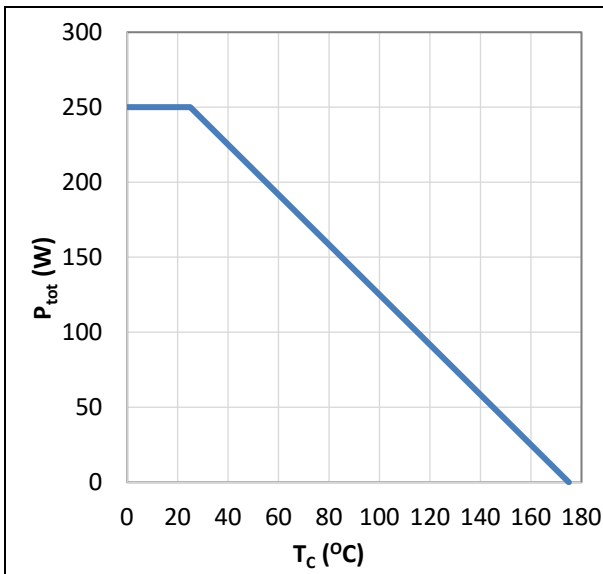
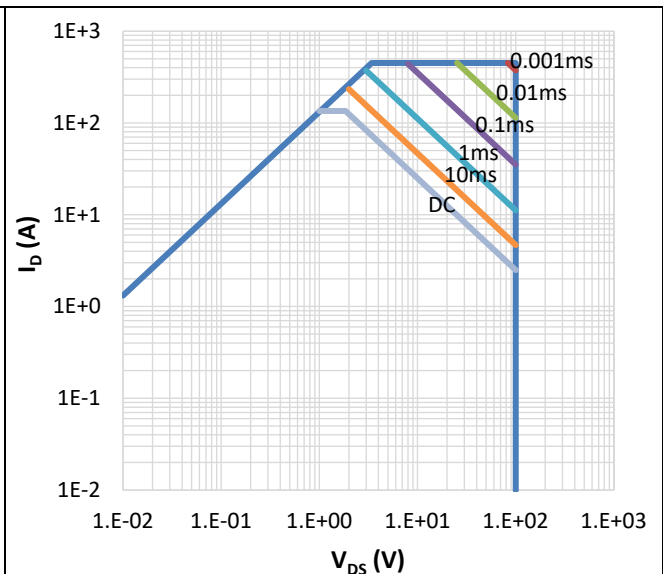

Fig 2: Safe operating area

$I_D = f(V_{DS});$  parameter : D = 0, T<sub>c</sub> = 25°C





100V N-Channel Power MOSFET

Electrical characteristics diagrams

Fig 3: Transient thermal impedance

$Z_{thJC} = f(tp)$ ; parameter :  $D = tp / T$

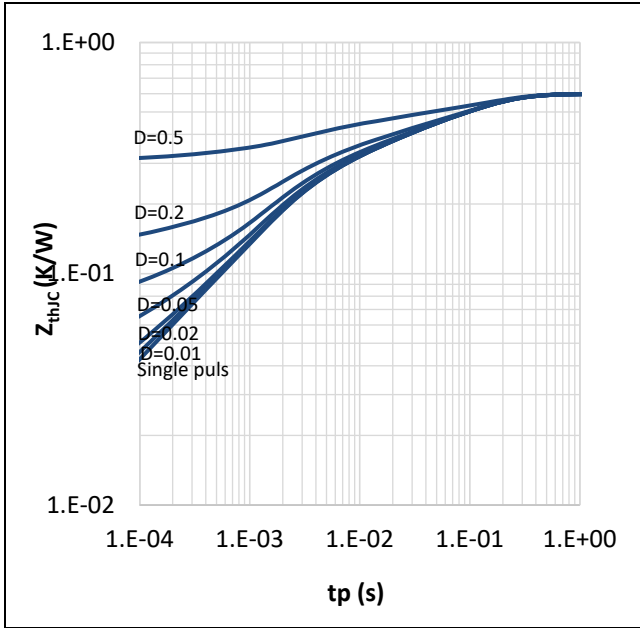

Fig 4: Typ. output characteristics

$I_D = f(V_{DS})$ ;  $T_j = 25^\circ C$ ; parameter:  $V_{GS}$

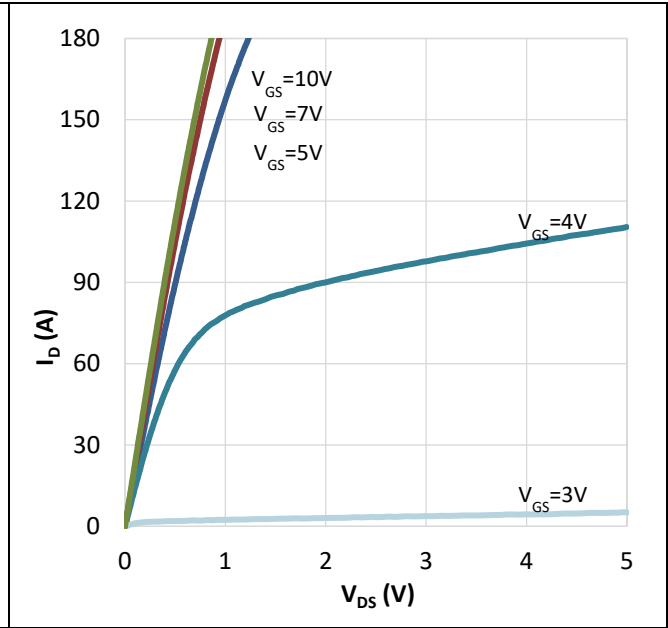

Fig 5: Drain current

$I_D = f(T_c)$ ;  $V_{GS} \geq 10V$

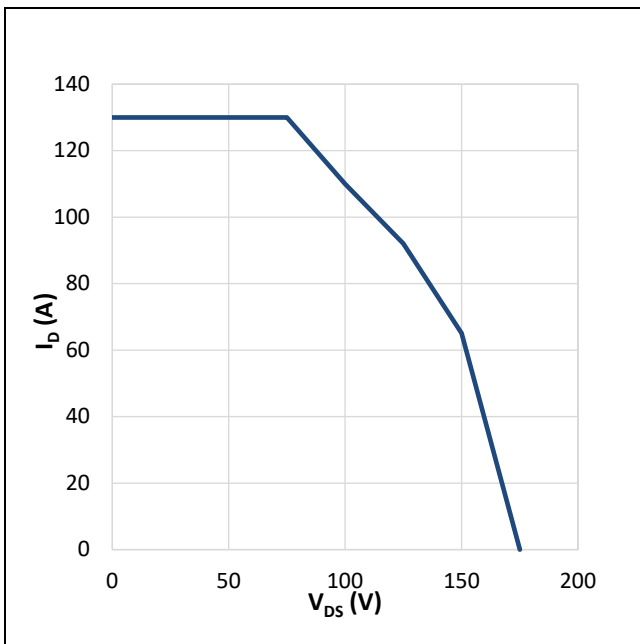
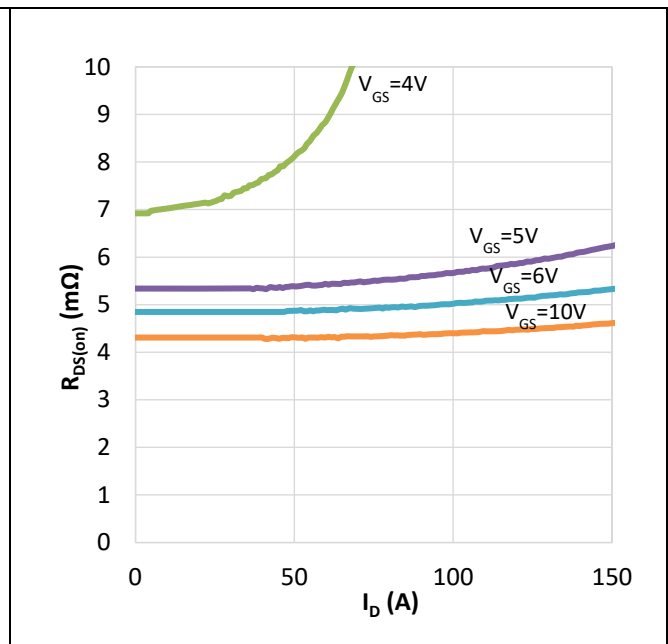

Fig 6: Typ. Drain source on-resistance

$R_{DS(on)} = f(I_D)$ ; parameter :  $tp = 50\mu S, T_j = 25^\circ C, V_{GS}$





100V N-Channel Power MOSFET

**Fig 7: Drain-source on-state resistance**

$R_{DS(on)} = f(T_j)$ ; parameter :  $I_D = 50A, V_{GS} = 10V$

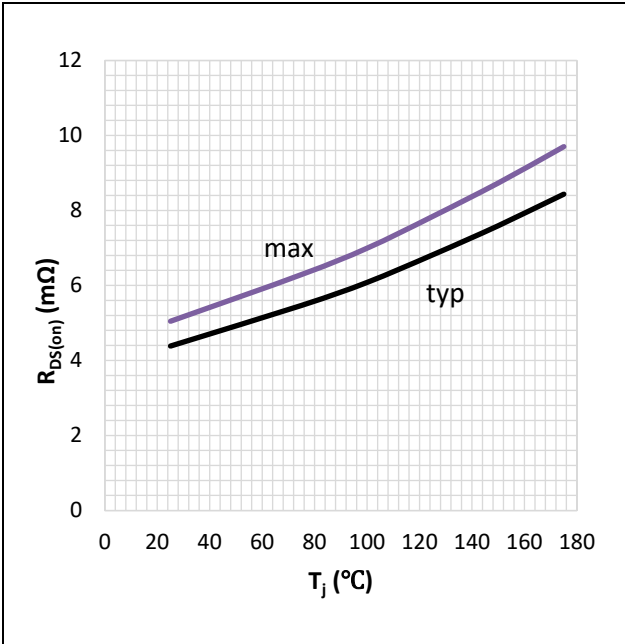

**Fig 8: Typ. transfer characteristics**

$I_D = f(V_{GS})$ ;  $V_{DS} \geq 2 \times I_D \times R_{DS(on) \text{ max}}$ ;  $T_j = 25^\circ\text{C}$ ; parameter :  $t_p = 50 \mu\text{s}$

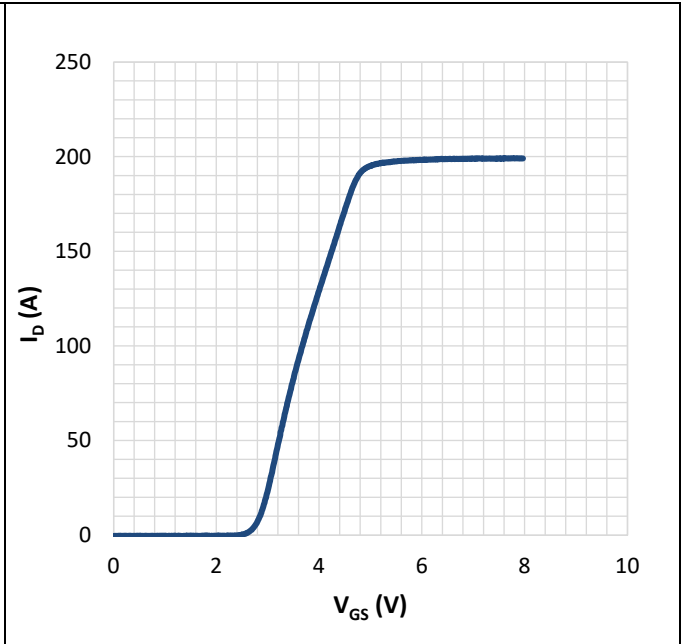

**Fig 9: Typ. gate charge**

$V_{GS} = f(Q_{GATE})$ ;  $I_D = 50A$  pulsed

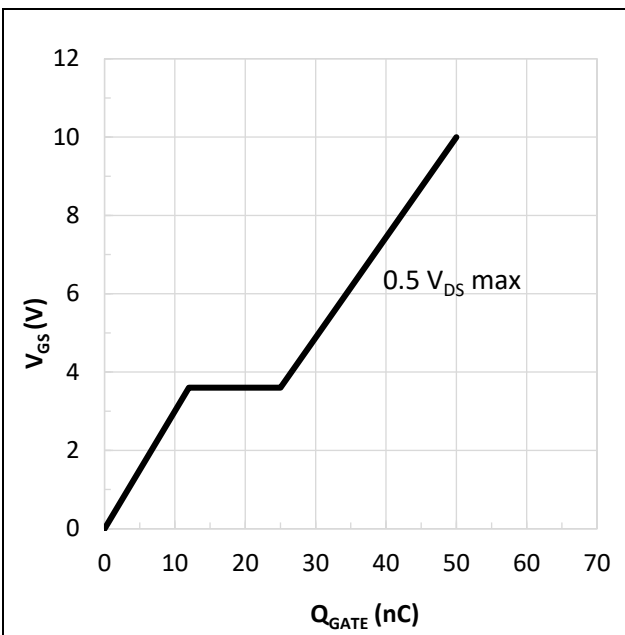

**Fig 10: Forward characteristics of body diode**

$I_F = f(V_{SD})$ ; parameter :  $T_j, t_p = 20\mu\text{s}$

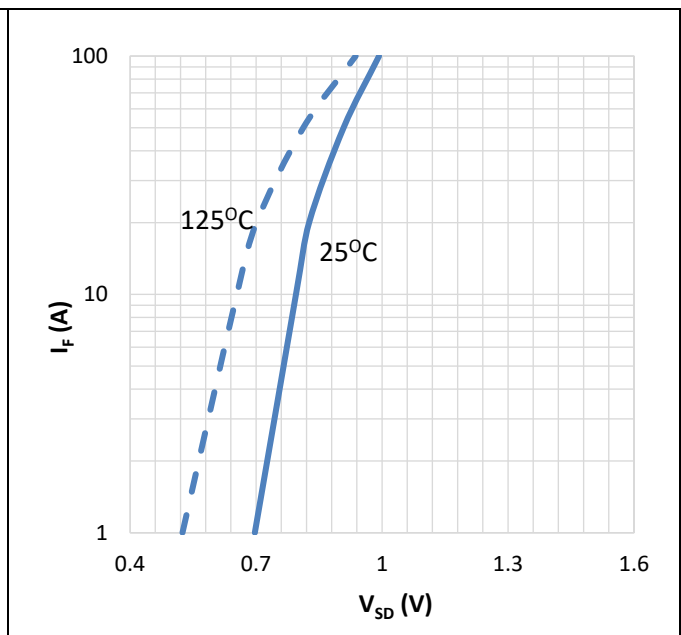



100V N-Channel Power MOSFET

**Fig 11: Drain-source breakdown voltage**

$BV_{DSS} = f(T_j)$

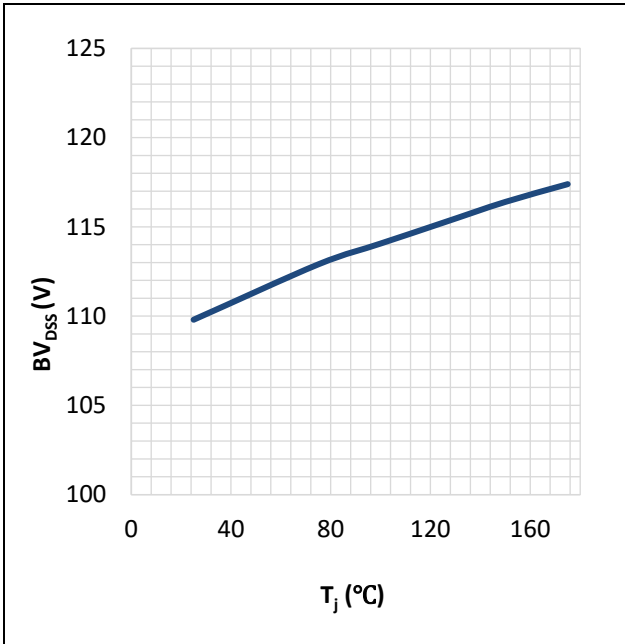

**Fig 12: Typ. capacitances**

$C = f(V_{DS})$ ; parameter :  $V_{GS} = 0V, f = 1MHz$

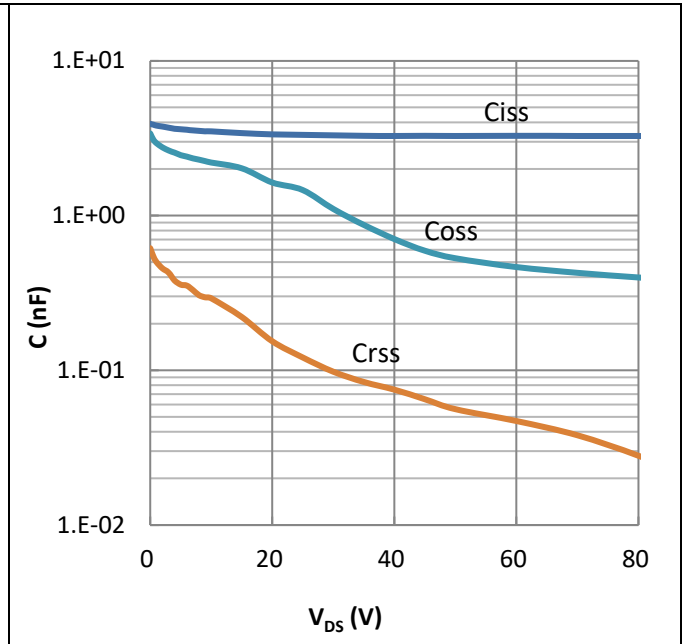

**Fig 13: Typ. Coss stored energy**

$E_{oss} = f(V_{DS})$

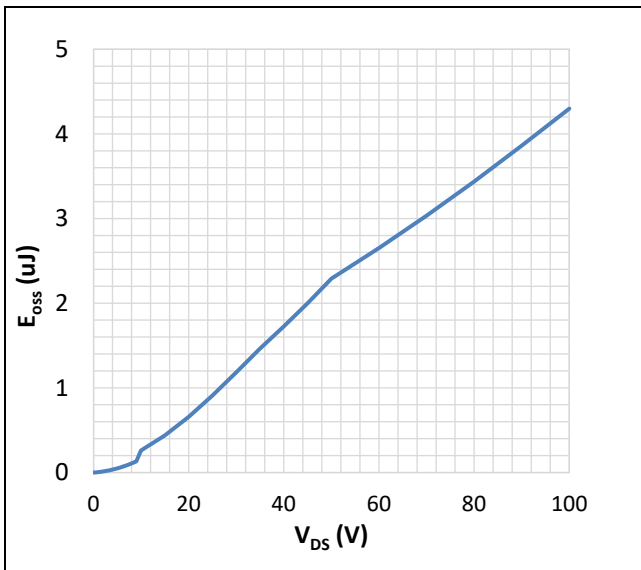



100V N-Channel Power MOSFET

**Test Circuit**

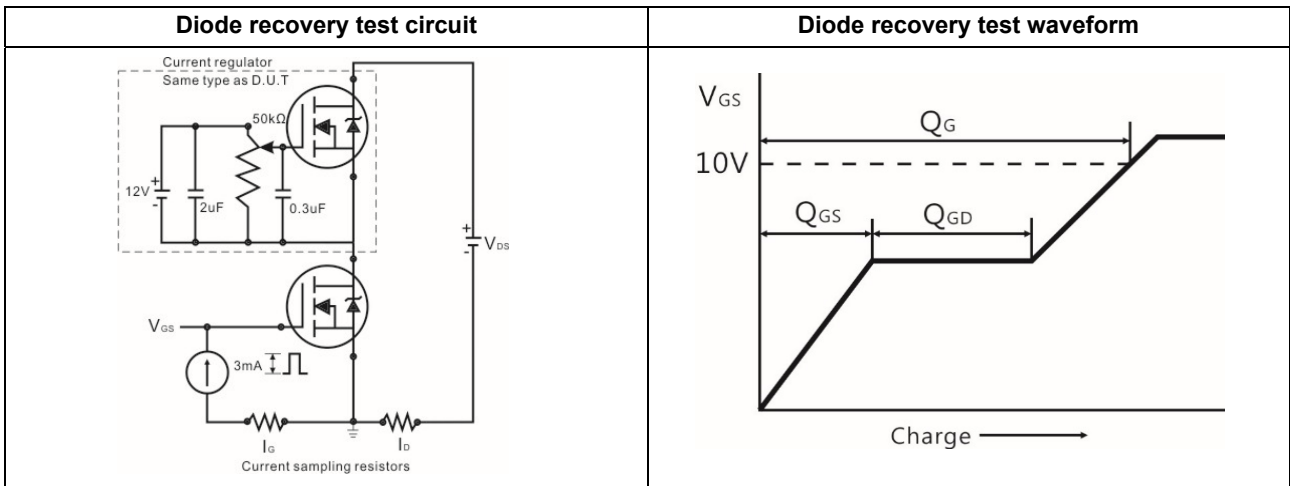
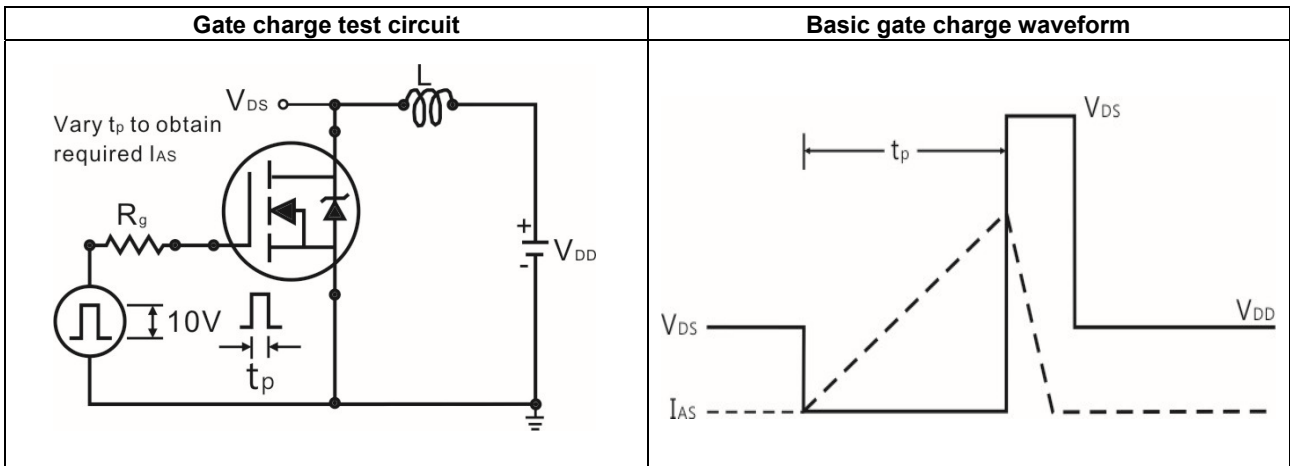
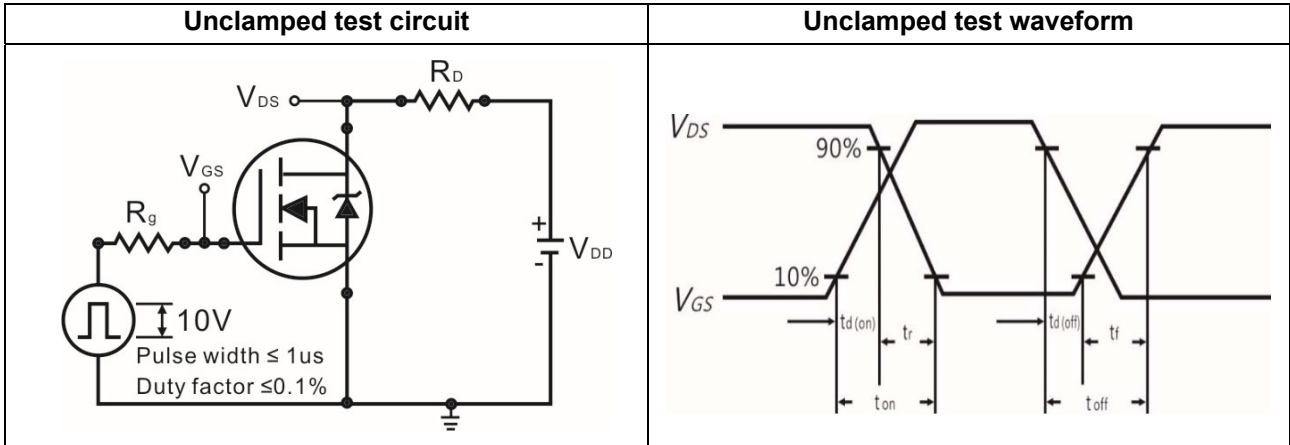



**Package outline**

**TO-220-AB**

